

Profile system

- All-glass horizontal sliding wall
- Top hung construction consisting of individually sliding panels
- Panels open to the inside, outside or to the centre
- Opening of panels by sliding to one side or to both sides
- Optionally with revolving blind frame
- Height adjustment after installation possible

Fittings

- All fittings are concealed within the profiles
- Low-maintenance, non-corroding and failsafe hardware components
- Elements are locked via a floor bolt
- An integrated pass through panel with a lever-operated multiple locking system, lock and profile cylinder can be provided

Running assembly

- Each element is guided by two running assemblies sliding in a ceiling mounted aluminium track
- Low-noise, low-wear, heat- and cold-resistant rollers
- Running assemblies pivot at any angle between 90° and 180°

Sealing and ventilation

- Vertical gap of approximately 3 mm between the panels
- Gap may be closed by fitting gap gaskets
- Brush gaskets are fitted horizontally at the top and bottom on the inside and outside
- Lower and upper brush gaskets are attached to the panel frames and not to the guide tracks

Glazing

- 8, 10 and 12 mm tempered safety glass panes (ESG-H)
- Panes secured via concealed screw-fixing system in top and bottom panel profiles
- Subsequent replacement of panes without difficulty
- Subsequent replacement of panels without difficulty



Basic parking bay designs

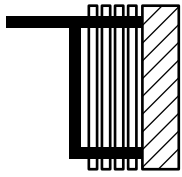

Design 1

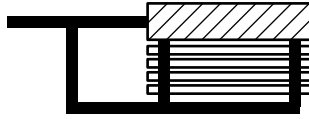

Design 2

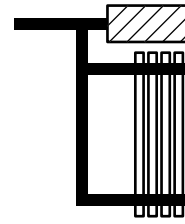

Design 3

Other parking bay designs on request

Corner angles 90°

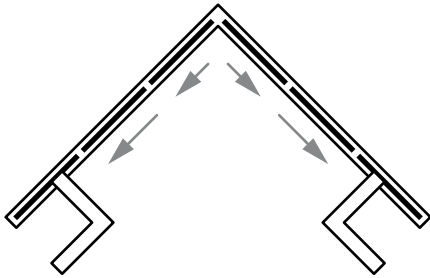

Corner angles 90°-180°

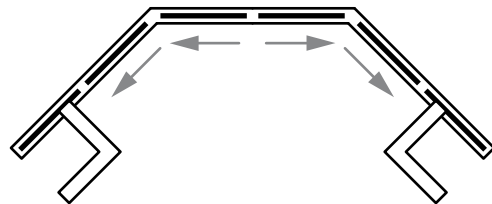
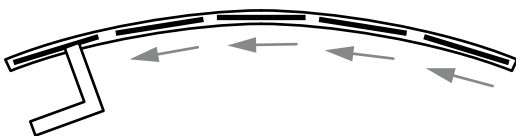

Other floor plan geometries upon request

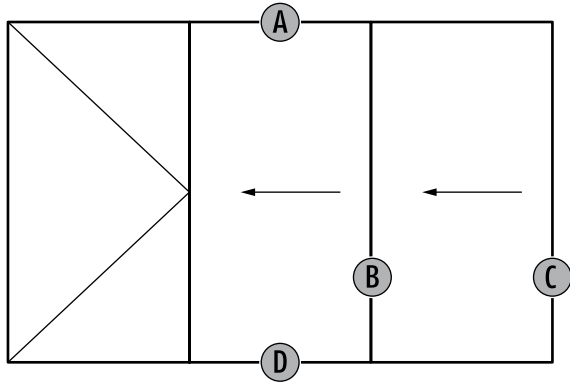

Details at uneven panel partition in one direction

Panel size diagram

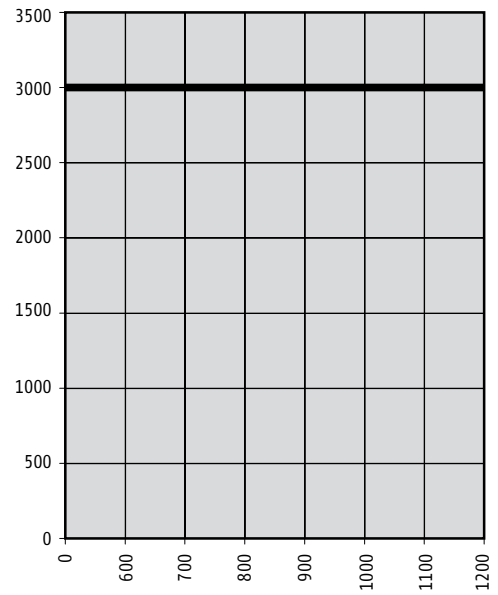

Ref.	Section	Description	Page
--	SF40HSW-001	Vertical-Section, panel profile + glazing variants	4
D	SF40HSW-004	Vertical-Section, locking socket	4
D	SF40HSW-005	Vertical-Section, flush bottom track	4
A	SF40HSW-002	Vertical-Section, top track standard	4
A	SF40HSW-003	Vertical-Section, top track + overlay profile inside + outside	5
B	SF40HSW-101	Horizontal-Section, panel - panel	5
C	SF40HSW-102	Horizontal-Section, panel - blind frame	5
B	SF40HSW-103	Horizontal-Section, panel - panel inside bending 162° - 180°	5
B	SF40HSW-104	Horizontal-Section, panel - panel inside bending 90° - 162°	6
B	SF40HSW-105	Horizontal-Section, panel - panel outside bending 120° - 180°	6
B	SF40HSW-106	Horizontal-Section, panel - panel outside bending 90° - 120°	6

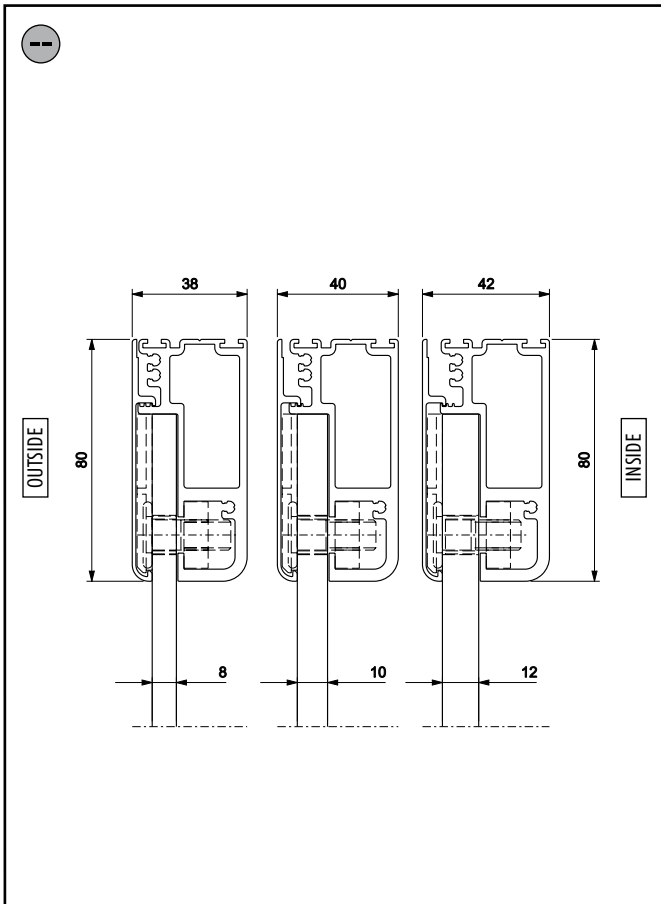

Description: Vertical-Section, panel profile + glazing variants	System: SF40 H-S-W
	Detail-No.: SF40HSW-001

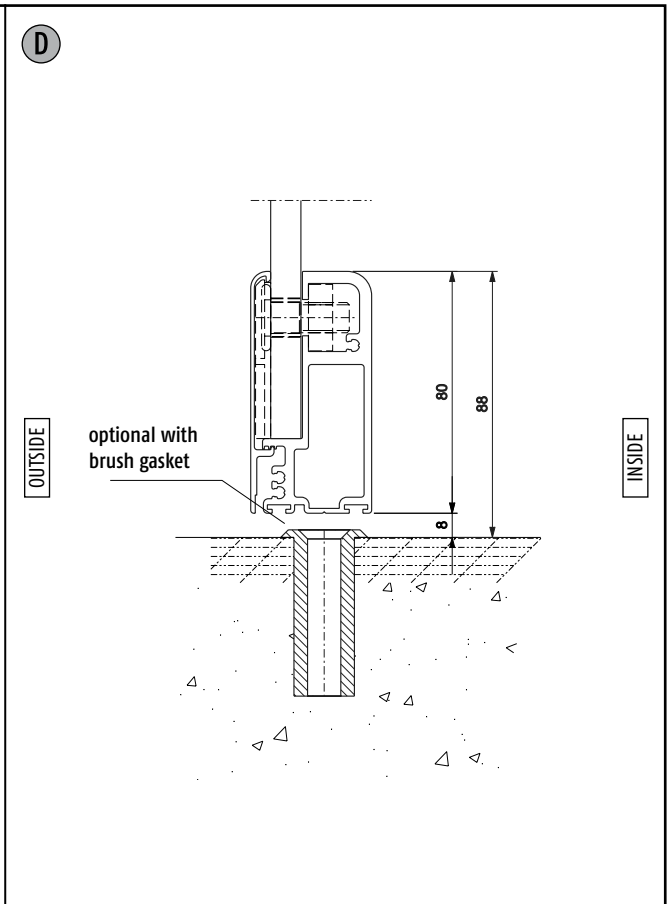

Description: Vertical-Section, locking socket	System: SF40 H-S-W
	Detail-No.: SF40HSW-004

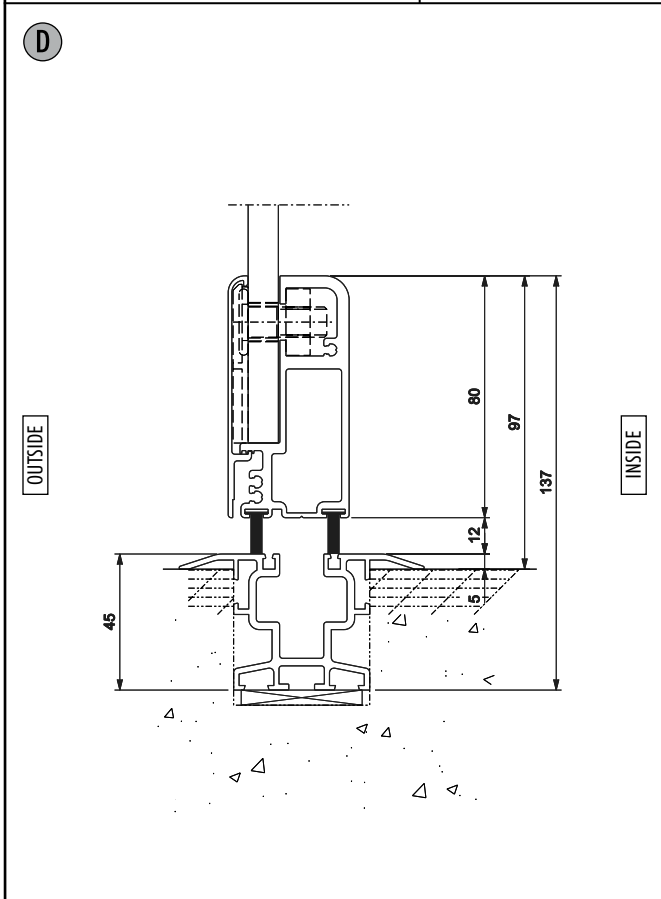

Description: Vertical-Section, flush bottom track	System: SF40 H-S-W
	Detail-No.: SF40HSW-005

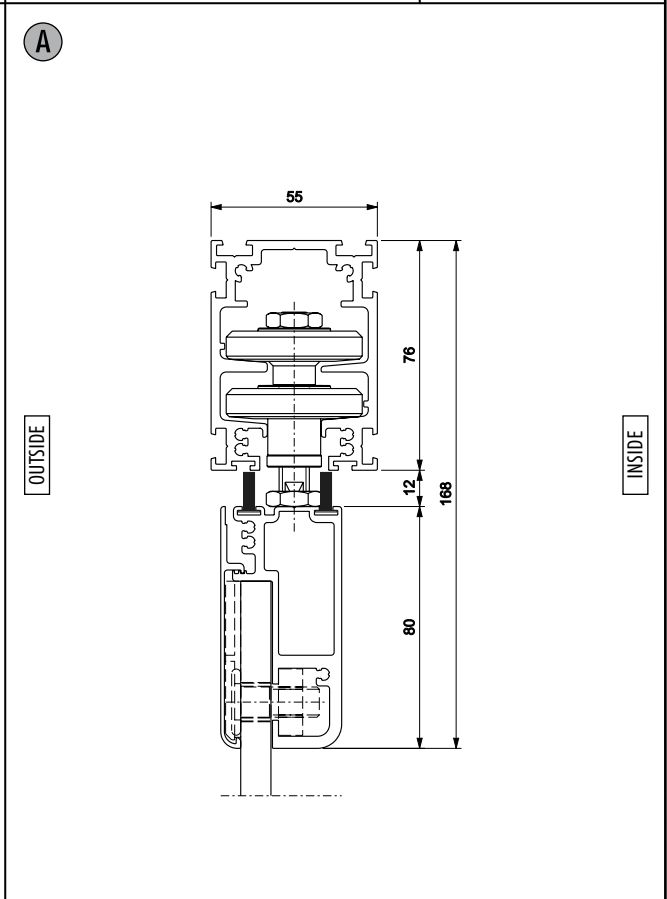

Description: Vertical-Section, top track standard	System: SF40 H-S-W
	Detail-No.: SF40HSW-002

<p>A</p>	<p>B</p> <p>OUTSIDE</p> <p>INSIDE</p>		
<p>Description: Vertical-Section, top track + overlay profile inside + outside</p>	<p>System: SF40 H-S-W Detail-No.: SF40HSW-003</p>	<p>Description: Horizontal-Section, panel - panel</p>	<p>System: SF40 H-S-W Detail-No.: SF40HSW-101</p>
<p>C</p> <p>OUTSIDE</p> <p>INSIDE</p>	<p>B</p> <p>OUTSIDE</p> <p>INSIDE</p>		
<p>Description: Horizontal-Section, panel - blind frame</p>	<p>System: SF40 H-S-W Detail-No.: SF40HSW-102</p>	<p>Description: Horizontal-Section, panel - panel inside bending 162° - 180°</p>	<p>System: SF40 H-S-W Detail-No.: SF40HSW-103</p>

<p>B OUTSIDE</p> <p>INSIDE</p>	<p>B OUTSIDE</p> <p>INSIDE</p>		
<p>Description: Horizontal-Section, panel - panel inside bending 90° - 162°</p>	<p>System: SF40 H-S-W Detail-No.: SF40HSW-104</p>	<p>Description: Horizontal-Section, panel - panel outside bending 120° - 180°</p>	<p>System: SF40 H-S-W Detail-No.: SF40HSW-105</p>
<p>B OUTSIDE</p> <p>INSIDE</p>			
<p>Description: Vertical-Section, panel - panel outside bending 90° - 120°</p>	<p>System: SF40 H-S-W Detail-No.: SF40HSW-106</p>		